

apcdayliter®

Fire and
Smoke Vents

*Smoke is the
most deadly
part of a fire*



Construction Specialties

APC Vents are the safest way to protect the building's occupants—and firefighters.

The National Building Codes demand fire vents for most industrial buildings.

Fire officials know that smoke is the deadliest part of a fire. That's why Section 910 of the International Fire Code mandates the use of automatic smoke control systems in high-piled storage facilities and in most one-story buildings greater than 50,000 square feet. **Smoke**

vents eliminate the need to cut holes in the roof.

One of the first things firefighters do when they arrive at a fire is cut holes in the roof. APC smoke vents automatically open to vent toxic smoke and gases, reduce flashback and lower the building's internal temperature. Firemen can get into buildings faster to attack the firebase directly. **Sprinklers alone**

can't always save lives and property.

Sprinklers clearly reduce fatalities and property loss, but their reliability can be questioned. The U.S. Consumer Product Safety Commission (CPSC) statistics suggest that sprinkler systems often fail to work properly due to a variety of reasons. But when sprinklers are used in combination with rooftop vents, fire safety in industrial buildings can be dramatically improved.

Rooftop vents improve fire fighting.

Fire vents also reduce lateral fire spread by preventing mushrooming heat from igniting other materials. APC vents improve visibility, saving precious time locating the fire seat and preventing collateral water damage.

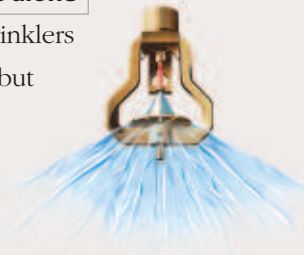

In one-story buildings fire and smoke spreads laterally and rapidly. In minutes smoke and gases fill the entire structure.

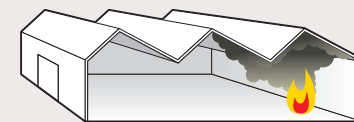

Unventilated building—Fire after
2 minutes

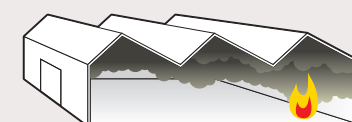

Unventilated building—Fire after
3 minutes

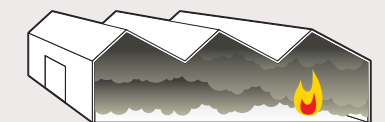

Unventilated building—Fire after
4 minutes

Six reasons why reliable, economical APC Fire Vents are the best choice

800.222.0201 • www.apcdayliter.com

1 APC Dayliter® vents work every time thanks to the laws of science.

APC Dropout vents rely on gravity and the special heat-sensing property of its dome material. When thermally activated by the rapid heat rise from fire, dome material softens and releases from its retaining frame venting smoke and gas.



2 Works With All Sprinkler Systems

Our APC vents work with any sprinkler system including ESFR sprinklers. Our vents operate within five minutes with exposure to fire, and well above 260° sprinkler activation temperatures. If a specific temperature release above 360° is required, our model AFL can be used.



3 Strong Yet Lightweight

A typical 4' x 8' APC unit weighs 110 lbs, yet the dome material is one of the industry's strongest. APC Quadri-dome resists hail, industrial debris and errant birds.



4 Meets Code

Section 910.2 of the IBC demands that most one-story undivided buildings over 50,000 sq. ft. have smoke vents on the roof. APC vents meet IBC and all older national codes.



5 No Moving Parts to Fail

APC's drop-out design prevents possible lid closures and is unaffected by snow loads. APC vents have no moving parts to corrode, and they do not require inspection or maintenance.

6 Half the Cost of Mechanical Systems and Exhaust Fans

APC vents are not only reliable but are extremely cost effective. Easy to install, even in large units, APC vents can offer building owners substantial savings over mechanical vents. APC is the clear choice in smoke and heat vents.



The facts don't lie! Judge for yourself.

Below is a comparison of APC Dayliter and mechanical vents.

Mechanical Vents

Meets International Building Codes	Yes
Operation	Pop-Up Fusible Link
Vent, Heat, Smoke & Gas	Yes
Works With Sprinklers	Yes
Moving Parts That Can Fail	Yes
Standard Fall Protection	No
Unit Weight (4' x 8')	300-700 lbs.

APC Drop-Out Vents

Meets International Building Codes	Yes
Operation	Drop Out Fusible Dome
Vent, Heat, Smoke & Gas	Yes
Works With Sprinklers	Yes
Moving Parts That Can Fail	No
Standard Fall Protection	Yes
Unit Weight (4' x 8')	110 lbs.

APC Smoke Vents

The rapid heat rise from fire causes the APC heat sensitive Quadri-Dome glazing to shrink and drop out of the opening automatically creating an unobstructed vent for heat, smoke, and gas. APC units will reach full open position within five minutes after initial exposure to fire and before the fire reaches 500° F.

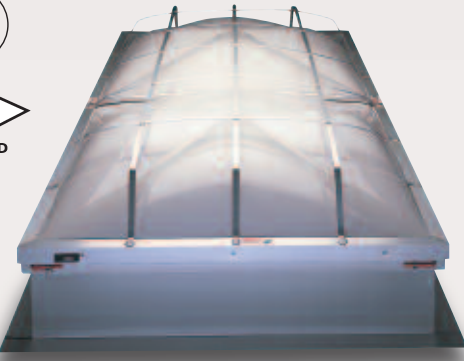

- Model AUL**
- Meets UL standard 793 for Automatically Operated Smoke and Heat Vents.
 - Only UL-listed drop-out gravity vent available.
 - Release rods standard for manual operation.
- Model AFM** meets FM test standard 4430 for smoke and heat vents.
- Model AFL** meets FM recommendations for high temperature release vents with ESFR sprinklers.

Curb Construction

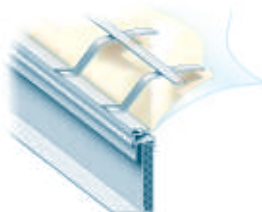

Double Wall
APC's double wall aluminum curb is welded at corners and come with Class A insulation for increased insulating values.

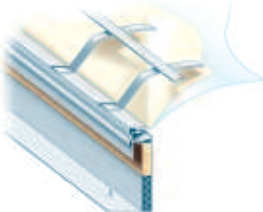

Single Wall
APC's most economical prefabricated curb consists of a wood nailer and Class A insulation. It allows for easy fastening of roof flashing.

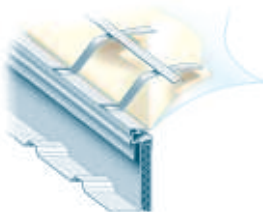

Metal Building Roof
APC's MB Double wall curbs are insulated and welded at corners for custom fit corrugated roof panels, or standing seam roofs.

Model AUL-2 & AFM-2

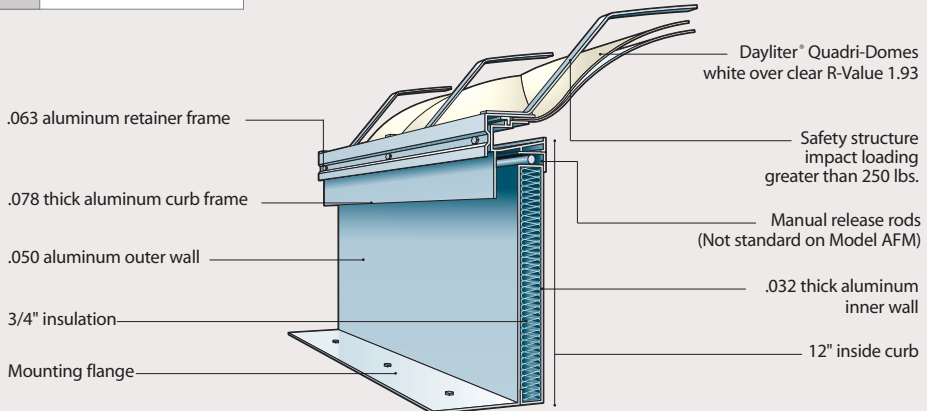

Standard Sizes*

48" X 48"
48" X 60"
48" X 72"
48" X 84"
48" X 90"
48" X 96"
60" X 101"
72" X 101"
60" X 154"
72" X 154"

APC Fire Vent Product Options

APC Dayliter® offers a variety of options to meet your specific fire and smoke vent project requirements.

800.222.0201 • www.apcdayliter.com

Curb Mounted Units

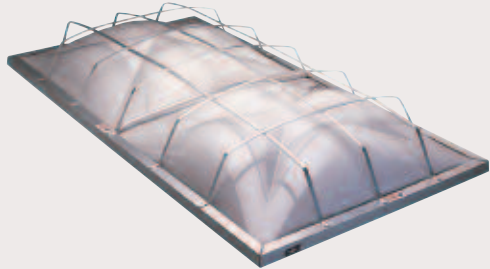

Curb Mounted Units
All APC Dayliter Fire Vents and Skylights can be designed to mount on curbs by others. To ensure that the units fit, please contact the APC factory for dimensions.

Safety Cages

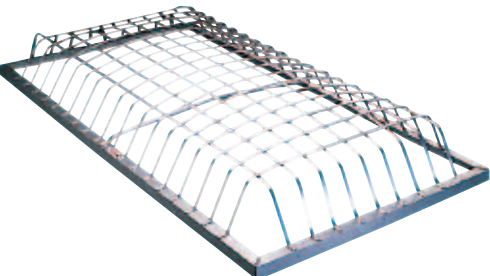

Safety Cages
APC Safety Cages are available for fire vents, skylights or explosion vents, including those of other manufacturers. APC offers standard cages as well as OSHA compliant safety cages with 4" x 4" spacing.

Oversized Units

Oversized units provide ultimate flexibility when cost savings and fewer roof openings are desired.

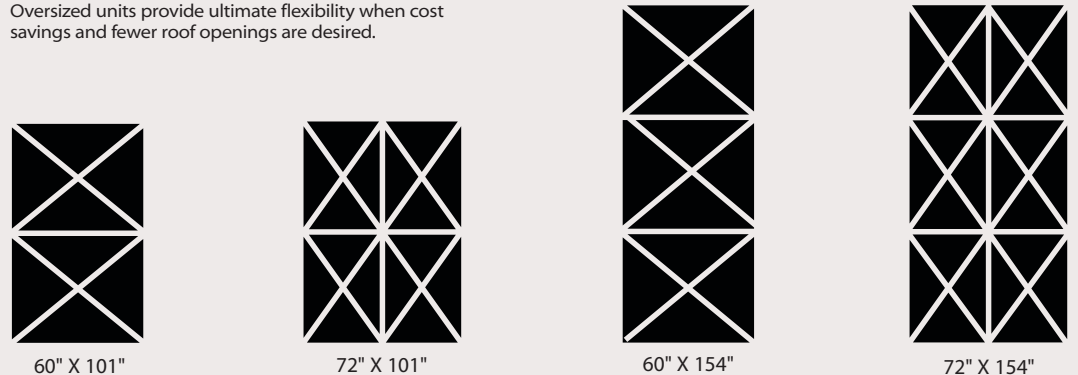

60" X 101" 72" X 101" 60" X 154" 72" X 154"



Construction Specialties

49 Meeker Avenue, Cranford, New Jersey 07016 U.S.A., 800-222-0201

895 Lakefront Promenade, Mississauga, Ontario L5E 2C2 Canada, 905-274-3611

© www.c-sgroup.com



The C/S Family of Products

For 60 years, Construction Specialties has been a leader in architectural specialty products, including: Acrovyn® Wall and Door Protection, Pedisystems® Entrance Flooring, Expansion Joint Covers, Cubicle Track and Curtains, Smoke and Explosion Venting Systems, Architectural Grilles, Architectural Louvers and Sun Controls.

We have operations throughout the world and can provide C/S Products virtually anywhere. For a complete list of our international locations, visit www.c-sgroup.com.

©Copyright 2007 Construction Specialties, Inc.

Construction Specialties, Inc. reserves the right to make design changes or to withdraw any design without notice. Printed in U.S.A. Series 08